

Basic User Manual

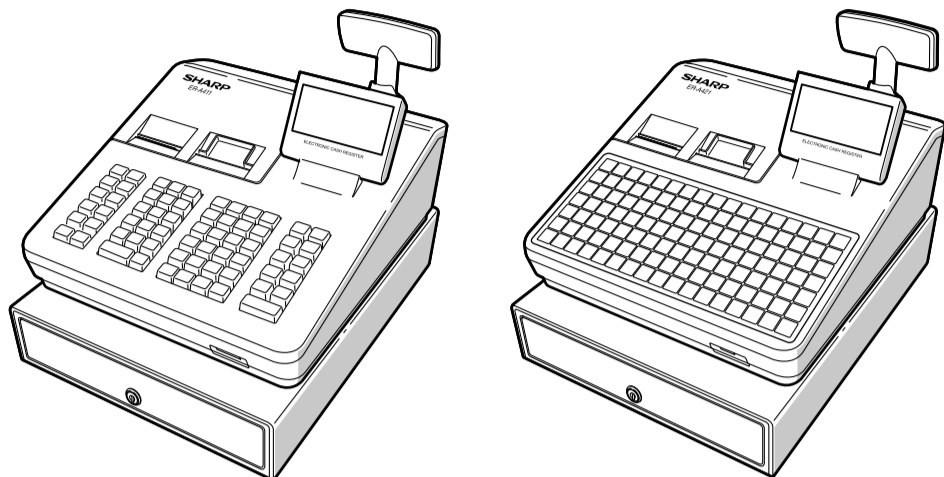

Printed in Thailand
14F TINSE2637BSZZ ①

Thank you very much for your purchase of the SHARP Electronic Cash Register, Model ER-A411/ER-A421. Please read this manual carefully before operating your machine in order to gain full understanding of functions and features. Please keep this manual for future reference. It will help you if you encounter any operational problems.

For a free download of the FULL DETAILED INSTRUCTION MANUAL, please go to the following related URL. For the countries other than described below, consult your authorized SHARP dealer.

- The United Kingdom and Republic of Ireland: www.sharp-pos.co.uk
- Netherlands and Belgium and Luxemburg: www.sharp.nl
- Sweden: www.sharp.se

CAUTION:
The cash register should be securely fitted to the supporting platforms to avoid instability when the drawer is open.

CAUTION:
The socket-outlet shall be installed near the equipment and shall be easily accessible.
VORSICHT:
Die Netzsteckdose muß nahe dem Gerät angebracht und leicht zugänglich sein.
ATTENTION:
La prise de courant murale devra être installée à proximité de l'équipement et devra être facilement accessible.
AVISO:
El tomacorriente debe estar instalado cerca del equipo y debe quedar bien accesible.
WARNING:
Det matande vägguttaget skall placeras nära apparaten och vara lätt åtkomligt.
LET OP:
Het stopcontact dient in de buurt van de kassa en gemakkelijk toegankelijk te zijn.

CAUTION:
For a complete electrical disconnection pull out the mains plug.
VORSICHT:
Zur vollständigen elektrischen Trennung vom Netz den Netzstecker ziehen.
ATTENTION:
Pour obtenir une mise hors-circuit totale, débrancher la prise de courant secteur.
AVISO:
Para una desconexión eléctrica completa, desenchufar el enchufe de tomacorriente.
WARNING:
För att helt koppla från strömmen, dra ut stickproppen.
LET OP:
Trek de stekker uit het stopcontact indien u de stroom geheel wilt uitschakelen.

WARNING:
This is a Class A product. In a domestic environment this product may cause radio interference in which case the user may be required to take adequate measures.

FOR CUSTOMERS IN U.K. IMPORTANT

The wires in this mains lead are coloured in accordance with the following code:

BLUE: Neutral
BROWN: Live

As the colours of the wires in the mains lead of this apparatus may not correspond with the coloured markings identifying the terminals in your plug proceed as follows.
The wire which is coloured BLUE must be connected to the terminal which is marked with the letter N or coloured black.
The wire which is coloured BROWN must be connected to the terminal which is marked with the letter L or coloured red.
The apparatus must be protected by a 3A fuse in the mains plug or distribution board.
CAUTION: DO NOT CONNECT THE LIVE (BROWN) WIRE OR THE NEUTRAL (BLUE) WIRE TO THE EARTH TERMINAL OF YOUR 3-PIN MAINS PLUG.

Shielded interface cables must be used with this equipment to maintain compliance with EMC regulations.

Noise level LpA: 57.6 dB(A-weighted)
Measured according to EN ISO 7779:2001
[Maximum value if the cash drawer springs open LpA: 77.0 dB(A-weighted)]

IMPORTANT

- Install the register in a location not subject to direct sunlight, unusual temperature changes, high humidity or splashing water.
Installation in such locations could cause damage to the cabinet and the electronic components.
- Never install the register in saline areas (e.g.: close to the sea).
Installing the register in such locations could cause component failure with the corrosion.
- Never operate the register with wet hands.
The water could seep into the interior of the register and cause component failure.
- When cleaning the register, use a dry, soft cloth. Never use solvents, such as benzene and/or thinner.
The use of such chemicals will lead to discoloration or deterioration of the cabinet.
- The register plugs into any standard wall outlet (official (nominal) voltage).
Other electrical devices on the same electrical circuit could cause the register to malfunction.
- If the register malfunctions, call your authorized SHARP dealer for service - do not try to repair the register yourself.
- For complete electrical disconnection, disconnect the main plug.
- To prevent the register from moving when the drawer opens, the fixing angle bracket is supplied with the register. If you want to install the bracket, consult your authorized SHARP dealer.
- In order to operate the register properly, you must initialize it before operating for the first time. To initialize the register, consult your authorized SHARP dealer.

PRECAUTION

This register has a built-in memory protection circuit which is operated by a rechargeable battery pack. It should be known that all batteries will, in time, dissipate their charge even if not used. Therefore to insure an adequate initial charge in the protection circuit and to prevent any possible loss of memory upon installation, it is recommended that each unit be allowed to be recharged for a period of 24 to 48 hours prior to use by the customer.

In order to charge the battery pack, the machine must be plugged in. This recharging precaution can prevent unnecessary initial service calls.
The battery pack is a consumable part, and its operating time will get shorter gradually each time it is recharged for memory backup.
When the battery pack cannot be charged enough to perform memory backup, it means that the service life of the battery pack has expired.
If this is the case, consult your authorized SHARP dealer.

Caution Scanner connection

In order to allow a plug & play connection of the optional scanner the Pin 9 of the D-Sub connector 1 (Channel 1) uses +5V. Be very careful of this +5V in case connection of a different device should be done so that a damage of the register or device is avoided.

1 Part Names and Functions

External View

Front view

ER-A411

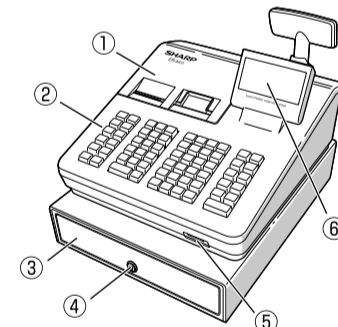

- ① Printer cover
- ② Keyboard
(ER-A411: Normal type, ER-A421: Flat type)
- ③ Drawer
- ④ Drawer lock
- ⑤ SD card slot
- ⑥ Operator display

Rear view

ER-A421

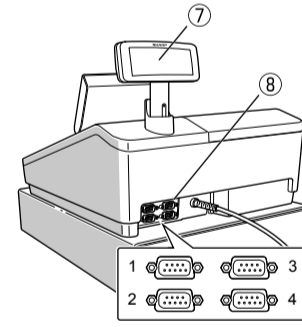
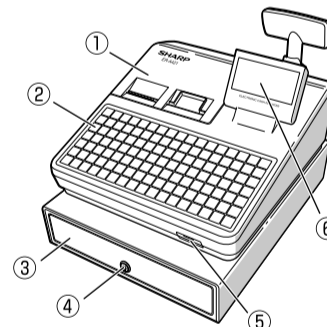

- ⑦ Customer display
- ⑧ RS232

Displays

Operator display

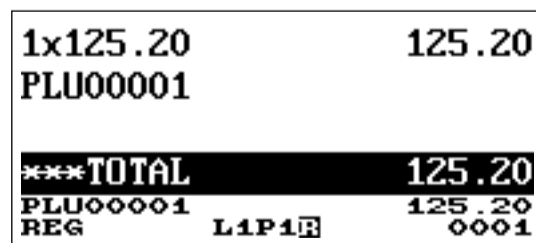

Mode name Status information Clerk/cashier code

Sales information area:
Sales information you have just entered such as items and prices will appear between 1st line and 3rd line. Total is always appear at 4th line.

Numeric entry area
Status area

Customer display

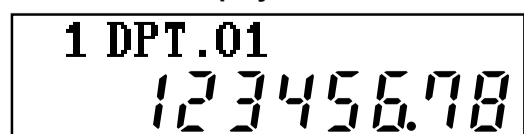

Text/message display area

Numeric display area

Keyboard

Standard keyboard layouts for ER-A411 and ER-A421 are as shown below.
For details on the key functions and optional keys, refer to "FULL DETAILED INSTRUCTION MANUAL".

ER-A411

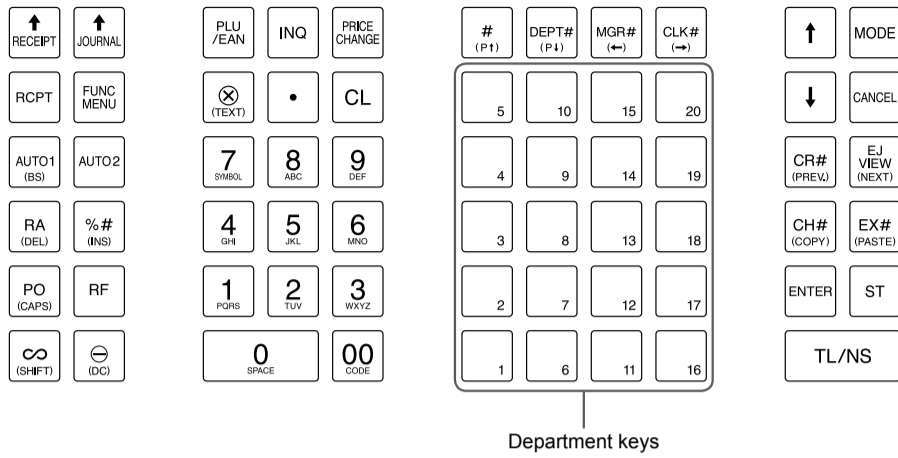

ER-A421

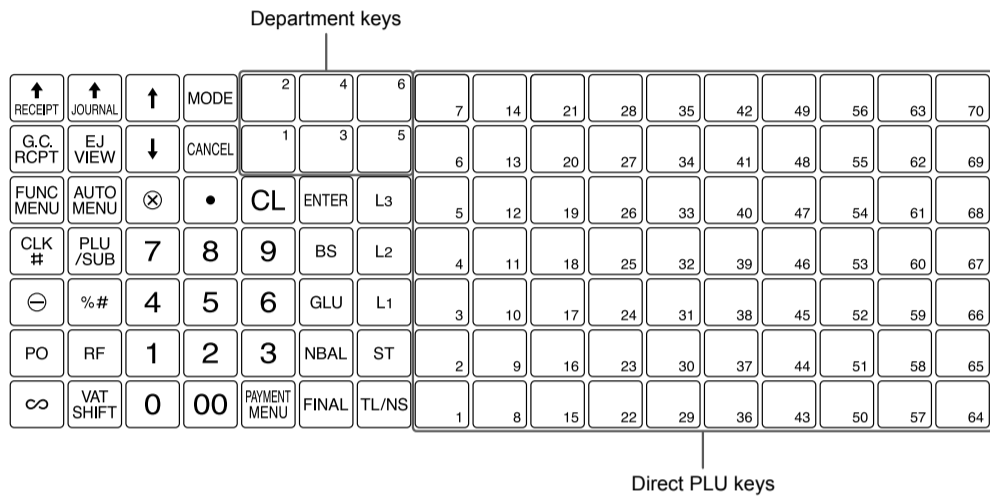

2 Selecting an Operating Mode

Mode Selection Window

When you turn the register on and press the **MODE** key, the mode selection window will appear on the display. For example, when a clerk is signed on, the following window will appear.

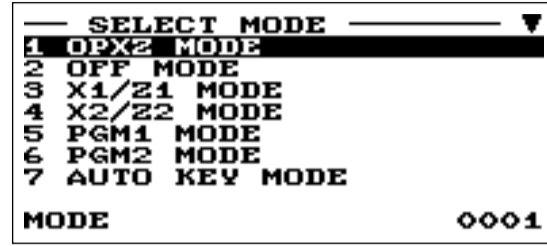

Operating Modes

You can select any mode other than REG from the list in the mode selection window. Your register supports the following operating modes:

REG mode	This mode allows you to enter various sales information. The mode selection window does not list this mode. To select this mode from the mode selection window, press the CANCEL key.
OPXZ mode	This mode allows clerks to take X or Z reports on their sales information.
OFF mode	This mode locks all operations of the register. When you select this mode, the window will disappear. Pressing any key turns the register ON.
X1/Z1 mode	This mode is used to take various daily total reports (X1/Z1 reports).
X2/Z2 mode	This mode is used to take various weekly or monthly reports (X2/Z2 reports).
PGM1 mode	This mode allows you to program those items which need to be changed often such as unit prices and discount percentages.
PGM2 mode	This mode allows you to program all items including date, time, functions, and the items that can be programmed in the PGM1 mode.
AUTO KEY mode	This mode allows you to program AUTO menu key and automatic sequencing keys.
SD CARD mode	This mode allows you to save and load the data of your register to and from an SD card.
iSDC mode	This mode allows you to save and load the data of your register to and from the server using a WiFi SD card.

Main Functional Overview

The register has the following main functions. For details, refer to "FULL DETAILED INSTRUCTION MANUAL".

Item Entries

- Single item entries
- Repeat entries
- Multiplication entries
- Split-pricing entries
- Successive multiplication entries
- Single item cash sale (SICS)/single item finalize (SIF) entries
- Scan entries

Special Entries for PLU/EAN

- Promotion function
- PLU/EAN link entries
- EAN learning function
- PLU/EAN information inquiry (view) function
- EAN price change function
- Set PLU/EAN entries
- PLU level shift (for direct PLUs)
- Price level shift
- Condiment entries

Display of Subtotals

- Subtotal
- Difference subtotal (Differ ST)

Finalization of Transaction

- Cash entries
- Check entries
- Credit entries

Computation of VAT (Value Added Tax)/Tax

- VAT/tax system
- VAT shift entries

Guest Check (GLU)

- Guest look up (GLU) system
- Deposit entries
- Bill separation by item, amount, person
- Bill printing

Auxiliary Entries

- Refund entries
- Percentage discount
- Amount discount
- Non-add code entry
- Tip entries

Payment Treatment

- Currency exchange
- Received-on-account entries
- Paid-out entries
- No-sale (exchange)
- Cashing a check
- Cash payment transfer

Age Verification

Overlapped Clerk Entry

Combined Cashier/Clerk Entry

Correction

- Correction of the last entry (direct void)
- Correction of the next-to-last or earlier entries (indirect void)
- Subtotal void
- Correction after finalizing a transaction

Special Printing Function

- Copy receipt printing
- Guest check receipt (bill print)
- Kitchen receipt print

Manager Mode

- Manager sign-on
- Override entries

Other Functions

- Starting cash memory
- Training mode
- SD card mode
- Electronic journal
- Electronic journal data view function
- WiFi SD card mode

Reports

- General report
- Transaction report
- Department report
- PLU/EAN report
- Hourly report
- Clerk report (All/Individual)
- Daily net report
- Electric Journal (Filter function)
- Flash reports
- Euro change
- Compulsory cash/check declaration

3 Prior to Making Entries

Preparations for Entries

Receipt and journal paper rolls

If the receipt or journal paper roll is not set in the register or it is getting low, install a new one according to section "Replacing the Paper Rolls" under "Operator Maintenance."

Receipt ON/OFF function

You can disable receipt printing in the REG mode to save paper using the receipt function. Press the **FUNC MENU** key. Select "1 RCP SW." and press the **ENTER** key. Select "2. OFF" to disable receipt printing and press the **ENTER** key. When the function is in the OFF status, the receipt off indicator "R" is highlighted.



Your register will print reports regardless of the receipt state. This means that the receipt roll must be installed even when the receipt state is "OFF".

Clerk assignment

Prior to any item entries, a clerk must enter his/her clerk code into the register.

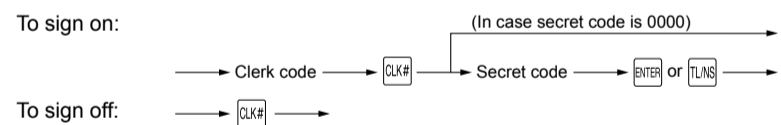

Error Warning

In the following examples, your register will go into an error state accompanied with a warning beep and the error message on the display. Clear the error state by pressing the **CL** key and then take the proper action to remedy the problem.

- When you exceed a 32-digit number (entry limit overflow):
Cancel the entry and re-enter a correct number.
- When you make an error in key operation:
Clear the error and try the entry again.
- When you make an entry beyond a programmable amount entry limit:
Check to see if the entered amount is correct. If it is correct, it can be rung up in the MGR mode. Contact your manager.
- When an including-tax subtotal exceeds eight digits:
Clear the error message by pressing the **CL** key and then press a media key to finalize the transaction.

4 Entries

Basic Sales Entry

Listed below is a basic sales entry example when selling items by cash. For details, refer to "FULL DETAILED INSTRUCTION MANUAL".

1. Enter the clerk code and press the **CLK#** key.
2. Enter the unit price and press the appropriate department key.
3. Repeat step 2 for all department items.
4. When the item entry is completed, press the **ST** key. The total amount due is displayed.
5. Receive the amount from your customer, and enter the amount by the numeric keys.
6. Press the **TLSN** key. The change due is displayed, and the drawer is opened.
7. Close the drawer.

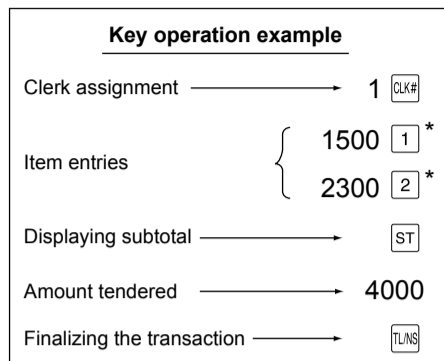

* **1 2** : indicate department keys.

Department Entries

Enter a unit price and press a department key. If you use a programmed unit price, press a department key only.

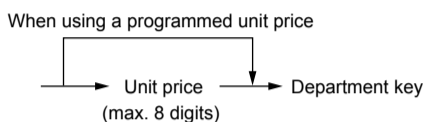

PLU (Price Look Up) Entries

PLU code entry (max. 5 digits)

Enter a PLU code using the numeric keys, and press the **PLU/EAN** key. For example, enter "71" and press the **PLU/EAN** key for "PLU 00071". For ER-A421, press the **PLU/SUB** key instead of the **PLU/EAN** key.

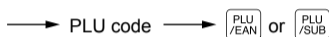

Direct PLU entry (ER-A421 only)

Enter a unit price and press a direct PLU key. If you use a programmed unit price, press a direct PLU key only.

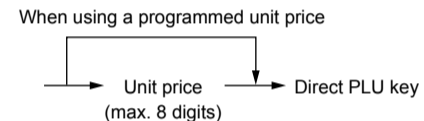

EAN Entries

Create EAN8/13-Codes in REG mode

This is the easiest way to register and to store EAN Codes before you open your shop or to work for the first time with the cash register. After an EAN code scanning, you may be requested to enter a unit price with the display "UNDEFINED CODE" and beep sound. Set the unit price, department code, and delete type.

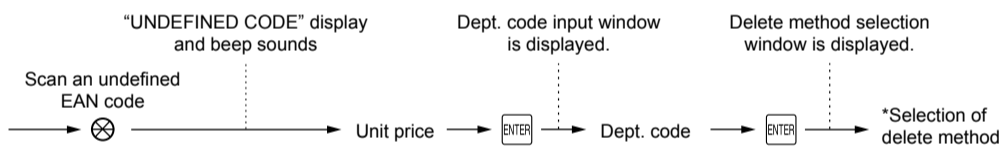

* Select "2 NO DELETE" to store the article continuously.

At the next scan entry of this EAN code, the registration is automatically done without the above steps.

EAN code entry (8 or 13 digits)

Enter the EAN code using the numeric keys, and press the **PLU/EAN** key. For ER-A421, press the **PLU/SUB** key instead of the **PLU/EAN** key.

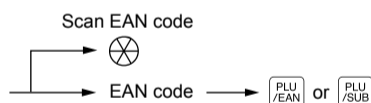

EAN code scanning (8 or 13 digits)

Read the EAN code on the item with the scanner.

Correction

Correction of entered number (CL)

When you enter an incorrect number, delete it by pressing the **CL** key immediately after the entry.

Correction of the last entry (∞)

If you make a mistake when making a department entry, PLU entry, percentage (%#) and discount (⊖), you can correct this entry by pressing the **∞** key immediately.

Correction of earlier entries (↑ → ∞)

You can correct any incorrect entry made during a transaction if you find it before finalizing the transaction by pressing the **TLSN** key. Move the cursor to the item to be voided and press the **∞** key.

Subtotal void (ST → ∞ → ST)

You can void an entire transaction. Once subtotal void is executed, the transaction is aborted and the register issues a receipt.

Press the **∞** key immediately after pressing the **ST** key. And then press the **ST** key again.

Correction after finalizing a transaction (VOID mode)

When you need to void incorrect entries that are found after finalizing a transaction or cannot be corrected by direct, indirect or subtotal void, the following steps should be taken.

1. Enter to the manager mode by following the steps on the right.

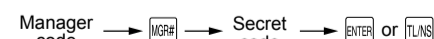

The **MGR#** key is not included in the standard keyboard for ER-A421. To use the VOID mode, consult your authorized SHARP dealer.

2. Press the **∞** key to put your register in the VOID mode.

3. Repeat the entries that are recorded on an incorrect receipt.

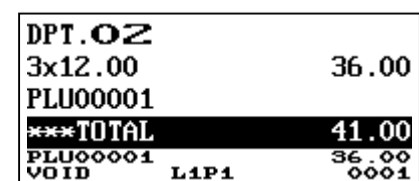

5 Reading and Resetting Sales

Overview

- Use the reading function (X) when you need to take the reading of sales information entered after the last resetting. You can take this reading any number of times. It does not affect the register's memory.
- Use the resetting function (Z) when you need to clear the register's memory. Resetting prints all sales information and clears the entire memory except for the GT1 through GT3, reset count, and consecutive number.
- X1 and Z1 reports show daily sales information. You can take these reports in the X1/Z1 mode.
- X2 and Z2 reports show periodic (monthly) consolidation information. You can take these reports in the X2/Z2 mode.
- In the OP X/Z mode, a clerk can take his or her report.
- This register supports various types of reports including general report, department report, PLU/EAN report, and clerk report. For details on available reports, refer to "FULL DETAILED INSTRUCTION MANUAL".
- If you want to stop the printing report, press the **CANCEL** key.



- When both sales quantities and sales amounts are zero, printing is skipped. If you do not want to skip, change the programming. For details, refer to "FULL DETAILED INSTRUCTION MANUAL".
- "X" represents read symbol and "Z" represents reset symbol in the reports.
- When printing is performed continuously, the printing may be intermitted for several seconds. After the intermission, the printing will be restarted.

How to Take a Report

1. Press the **MODE** key.
2. Select the appropriate mode from the following by using the **↓** key, and press the **ENTER** key.
 - 1 OPXZ MODE
 - 3 X1/Z1 MODE
 - 4 X2/Z2 MODE
3. Select the operation from the following by using the **↓** key, and press the **ENTER** key to display the items list.
 - 1 READING
 - 2 RESETTING
4. Select the appropriate report title.
5. Press the **TLSN** key.

Flash Report

You can take flash reports (display only) in the X1 mode for department sales, cash in drawer (CID) and sales total at the point you take the report.

1. Press the **MODE** key.
2. Select the "3 X1/Z1 MODE" by using the **↓** key, and press the **ENTER** key.
3. Select "3 FLASH MODE", and press the **ENTER** key.
4. Select the appropriate report title from the following by using the **↓** key.

1 DEPT. SALES	Department sales
2 CID	Cash in drawer
3 SALES TOTAL	Sales total
5. Press the **TLSN** key.



When you select "1 DEPT. SALES" in step 4, select the appropriate department from the departments list.

6 Operator Maintenance

In Case of Power Failure

When power is lost, the register retains its memory contents and all information on sales entries.

- When power failure is encountered in register idle state or during an entry, the register returns to the normal state of operation after power recovery.
- When power failure is encountered during a printing cycle, the register carries out the correct printing procedure after power recovery.

In Case of Printer Error

If the printer runs out of paper, the printer will stall, and "PAPER EMPTY" will appear on the display. Key entries will not be accepted. Referring to "Replacing the Paper Rolls" in this chapter, install a new paper roll in the proper position, then press the **CL** key. The printer will print the power failure symbol and resume printing.

If the print roller arm comes up, the printer stalls, and "HEAD UP" will appear on the display. Key entries will not be accepted. Push down the arm until it is securely locked, then press the **CL** key. The printer will print the power failure symbol and resume printing.

Cautions in Handling the Printer and Recording Paper

Cautions in handling the printer

- Avoid the following environments:
 - Dusty and humid places
 - Direct sunlight
 - Iron powder (A permanent magnet and electromagnet are used in this machine.)
- Never pull the paper when the print roller arm is locked. First lift up the arm, and then remove the paper.
- Never touch the surface of the print head and print roller.

Cautions in handling the recording paper (thermal paper)

- Use only the paper specified by SHARP.
- Do not unpack the thermal paper until you are ready to use it.
- Avoid heat. The paper will color at around 70°C.
- Avoid dusty and humid places for storage. Avoid direct sunlight.
- The printed text on the paper can discolor under the following conditions:
 - Exposure to high humidity and temperature
 - Exposure to the direct sunlight
 - Contact with glue, thinner or a freshly copied blueprint.
 - Heat caused by friction from scratching or other such means.
 - Contact with a rubber eraser or adhesive tape.
- Be very careful when handling the thermal paper. If you want to keep a permanent record, copy the printed text with a photocopier.

Replacing the Paper Rolls

The register can print receipts and journals. For the printer, you must install the paper rolls (receipt and journal paper rolls) provided with the register.

- Be sure to set a paper roll prior to using your machine, otherwise it may cause a malfunction.
- Be careful then to set the roll correctly.

(How to set the paper roll)

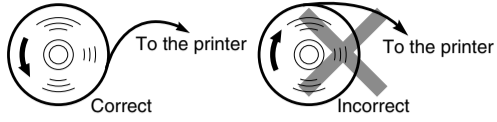

Recording paper specifications

Be sure to use paper rolls specified by SHARP.

The use of any other paper rolls than specified could cause paper jamming, resulting in register malfunction.

Paper specification

Paper width:	57.5 ± 0.5 mm
Max. outside diameter:	80 mm
Quality:	High quality (0.06 to 0.08 mm thickness)
Paper tube:	18 mm

Removing the paper rolls

When a red dye appears on the paper roll, it is time to replace the existing paper roll. Replace the paper roll with a new one. If you plan not to use your register for an extended period of time, remove the paper roll, and store it in the appropriate place.

1. Remove the printer cover.

<Receipt side>

2. ① Lift up the print roller release lever to unlock the print roller arm. The arm will come up slightly.
- ② Open the print roller arm of the receipt side.
3. Remove the paper roll from the paper roll cradle of the receipt side.

<Journal side>

4. Press the key to advance the journal paper until its printed part is out of the way.
5. Cut the paper and remove the take-up spool from the bearing.

6. Lift up the print roller arm of the journal side.

7. Remove the paper roll from the paper roll cradle of the journal side.

8. Remove the paper holding plate of the take-up spool, and remove the printed journal roll from the spool.

Installing the paper rolls

<Receipt side>

1. Remove the printer cover and open the print roller arm of the receipt side by following the steps in "Removing the paper rolls".
2. Set a paper roll in the paper roll cradle of the receipt side as per the diagram.



3. Feed the end of the paper along with the paper positioning guides as per the diagram.

4. While holding down the paper, slowly close the print roller arm of the receipt side, and push down the **(PUSH)** mark on the arm until you hear a click locking the arm.

NOTE If the print roller arm is not securely locked, printing is not done right. If this problem occurs, open the arm, and close the arm as instructed above.

5. Wait until the excess paper is automatically cut off, and remove it.

NOTE Do not remove the excess paper until the receipt cutter stops completely. Trying to remove the paper before the cutter stops completely could cause paper jamming.

<Journal side>

6. Lift up the print roller arm of the journal side.

7. Set a paper roll in the paper roll cradle of the journal side as per the diagram.

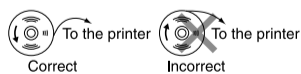

8. While holding down the paper, slowly close the print roller arm of the journal side, and push down the arm until you hear a click locking the arm.

9. ① Remove the paper holding plate from the spool.

② Insert the end of the paper into the slit in the spool. (Press the journal paper feed key to feed more paper if required.)

③ Wind the paper two or three turns around the spool shaft.

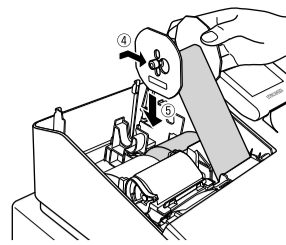

10. ④ Mount the paper holding plate onto the take-up spool.
- ⑤ Set the spool on the bearing, and press the journal paper feed key to take up excess slack in the paper.

11. Replace the printer cover.

12. Press the key to make sure the paper end comes out of the printer cover and clean paper appears.



If the paper end does not come out, open the printer cover, and pass the paper end between the paper cutter and the paper guide of the printer cover, and replace the printer cover.

Removing a paper jam

1. Remove the printer cover.
2. Lift up the print roller arm.
3. Remove the paper jam. Check for and remove any shreds of paper that may remain in the printer.
4. Reset the paper roll correctly by following the steps in "Installing the paper rolls".

Drawer Handling

Locking the Drawer

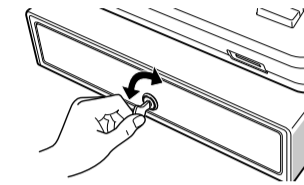

Develop the habit of locking the drawer when not using the register for any extended period of time.

To lock: Insert the key into the drawer lock and turn it 90 degrees counter-clockwise.

To unlock: Insert the key into the drawer lock and turn it 90 degrees clockwise.

Removing the Drawer

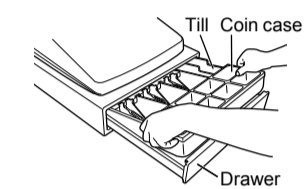

To remove the drawer, pull it out and lift it up.



- To prevent burglary, it is a good idea to empty the drawer after work and leave it open at the end of the day.
- Coin case is detachable.

Manually Opening the Drawer

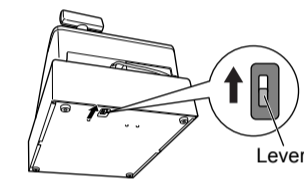

In case of a power failure or if the machine is out of order, locate the lever at the bottom of the machine and move it in the direction of the arrow to open the drawer. The drawer will not open if it is locked with the drawer lock key.

Before Calling for Service

If you encounter any of the following problems, please read below before calling for service.

The display does not illuminate.

- Is power supplied to the electric outlet?
- Is the power cord plug out or loosely connected to the electric outlet?
- Is the register in screen-save mode?

No receipt is issued.

- Is the receipt paper roll properly installed?
- Is there a paper jam?
- Is the receipt function in the "OFF" status?
- Is the print roller arm securely locked?

The display is illuminated, but the whole machine refuses entries.

- Is a cashier code assigned to the register?
- Is a clerk code assigned to the register?
- Is the register in the REG mode?

No journal paper is taken up.

- Is the take-up spool installed on the bearing properly?
- Is there a paper jam?

Printing is unusual.

- Are the printer head/sensor/roller clean?
- Is the paper roll properly installed?

Specifications

Model:

ER-A411/ER-A421

Dimensions:

360(W) × 425(D) × 365(H)* mm

* With the customer display popped up. When it is completely lowered, the height is 330 mm.

Weight:

Approx. 12.0kg

Power source:

Official (nominal) voltage and frequency

Power consumption:

Standby: 7.1W (220 to 230V, 50Hz/60Hz)

7.3W (230 to 240V, 50Hz)

Operating: 31.6W (220 to 230V, 50Hz/60Hz)

28.1W (230 to 240V, 50Hz)

Working temperatures:

0 to 40 °C

Display:

Operator display: LCD display with tilt mechanism
192(W) × 80(H) dots

Customer display: 2-line LCD display

Printer:

Type:

Two-station thermal printer

Printing speed:

Approx. 15 lines/second

Printing capacity:

30 digits each for receipt/journal paper

Other functions:

- Receipt ON/OFF function
- Compression print for an electronic journal/journal
- Receipt and journal independent paper feed function

Logo:

Graphic logo printing:

Size: 130(H) × 360(W) pixel

Area of black must be less than 35% of all area.

Logo message printing:

Logo message for the receipt

(max. 30 characters x 6 lines)

Paper Roll:

Width: 57.5±0.5 mm

Max. diam.: 80 mm

Quality: High quality (0.06 to 0.08 mm thickness)

Cash drawer:

5 slots for bills and 8 for coin denominations

Accessories:

Basic User Manual: 1 copy

Paper roll: 2 rolls

Take-up spool: 1

Paper holding plate: 1

Drawer lock key: 2

Standard key sheet: 1 (for ER-A421 only)

Programming key sheet: 1 (for ER-A421 only)

Fixing angle bracket: 1

SHARP

SHARP ELECTRONICS (Europe) Ltd.

4 Furzeground Way, Stockley Park Uxbridge,
UB11 1 EZ, United Kingdom

SHARP CORPORATION